

# KRE-O™

CREATE IT.

# TRANSFORMERS®

AGES 6 - 12



31144

# BUMBLEBEE™

75 PIECES



PRODUCT SHOWN IN FANTASY SITUATION  
PRODUCT DOES NOT CONVERT

# CREATE IT WITH KRE-O™ CONSTRUCTION SETS!

- Sort your blocks by color and size to make them easier to find.
- Build on a large, flat surface.

## KRE-O TRANSFORMERS™



**BUILD  
SPORTS CAR OR ROBOT**

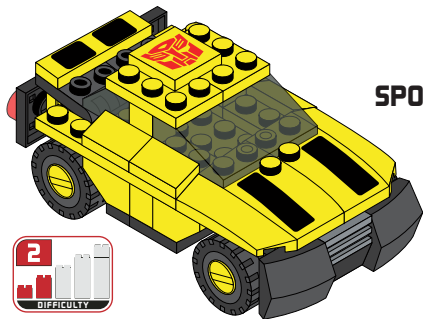

**VEHICLE MODE - PAGE 3**

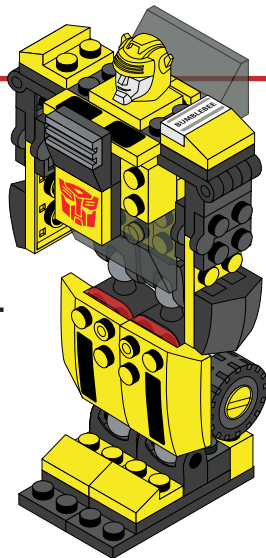

**ROBOT MODE - PAGE 17**

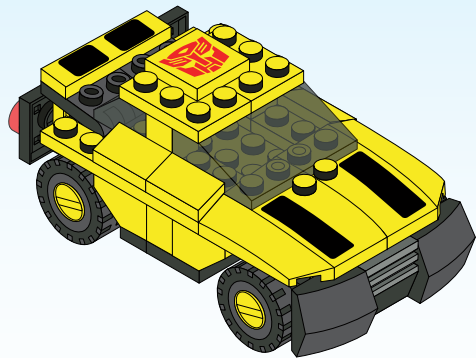

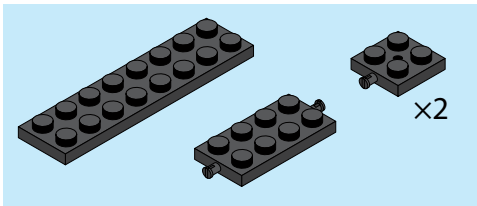

1

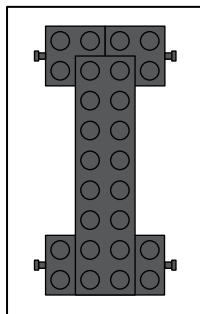
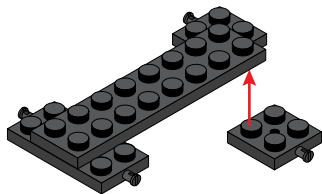

TOP VIEW

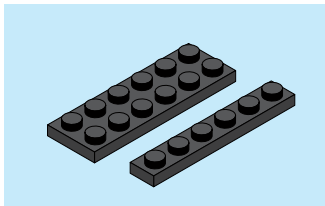

2

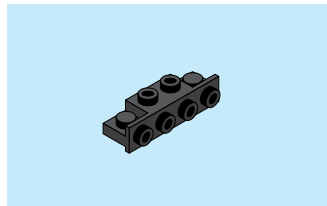
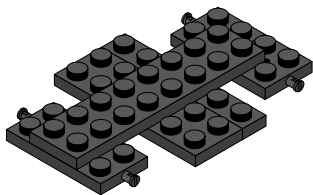

3

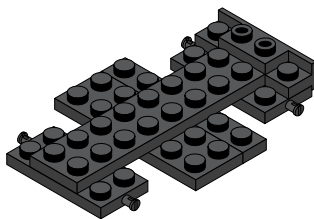

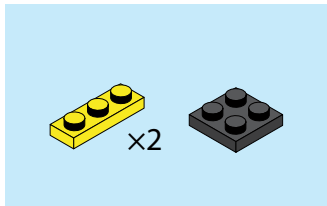

4

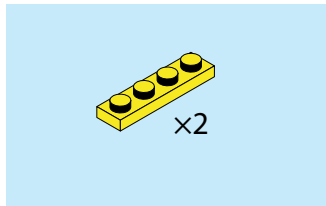
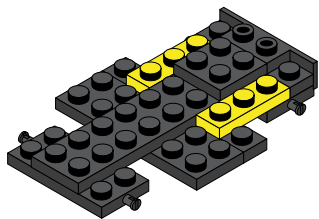

5

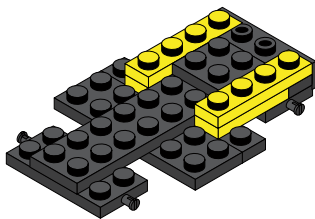

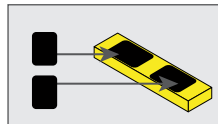
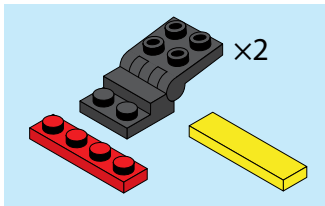

6

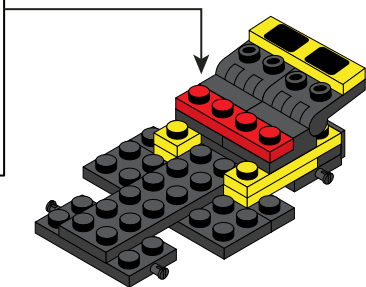
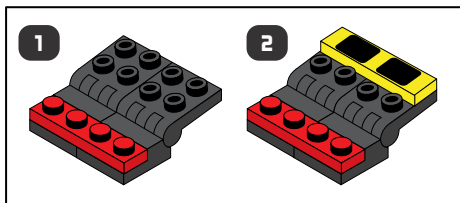



x2

7

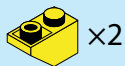
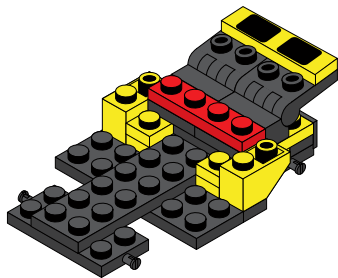

x2



x2

8

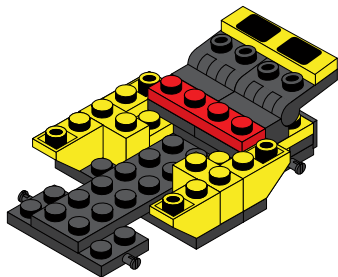



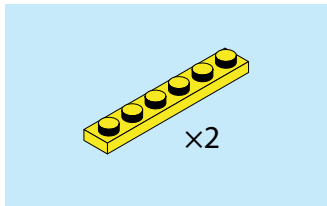

9

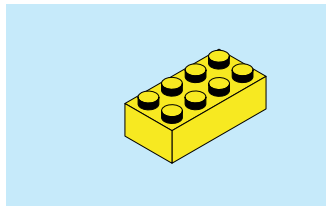
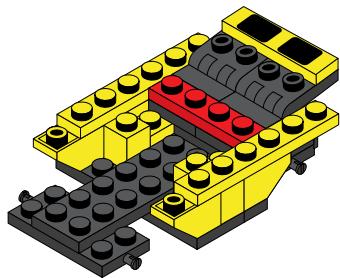

10

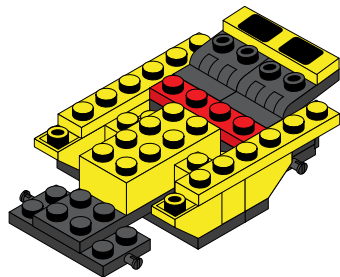



11

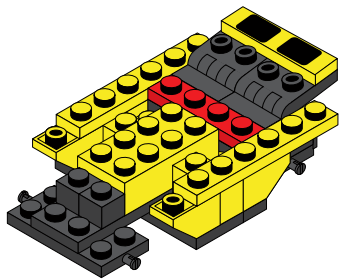

12

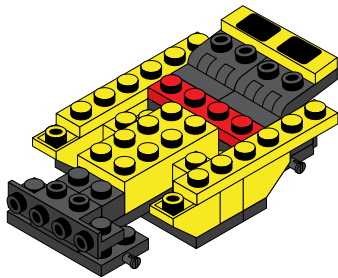

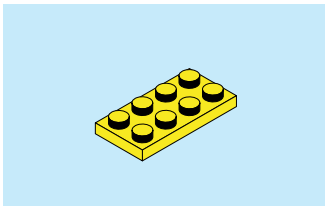

13

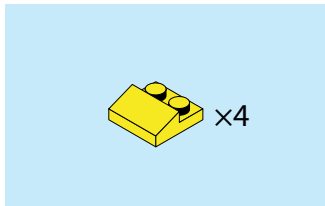
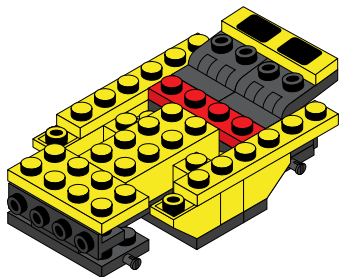

14

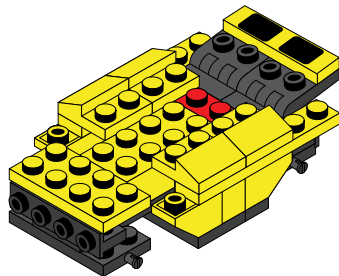

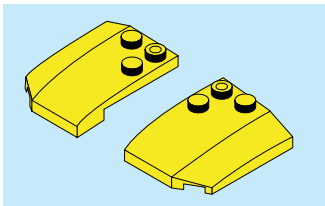

15

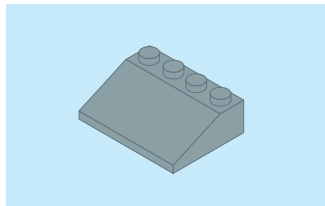
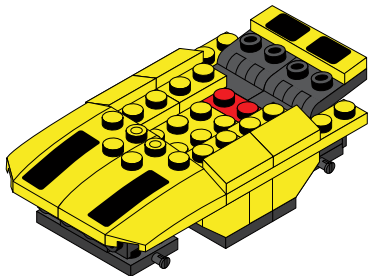
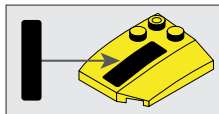
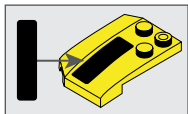

16

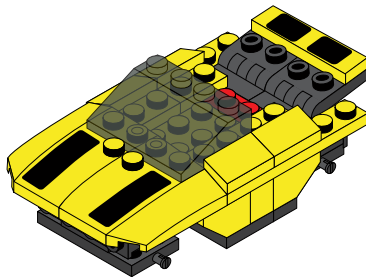

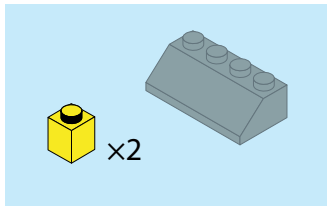

17

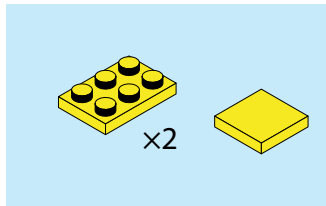
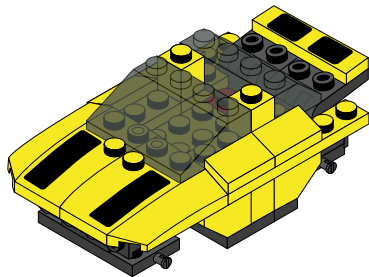

18

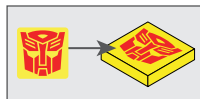
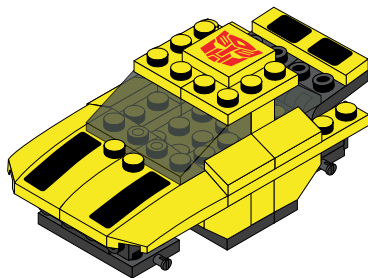



19

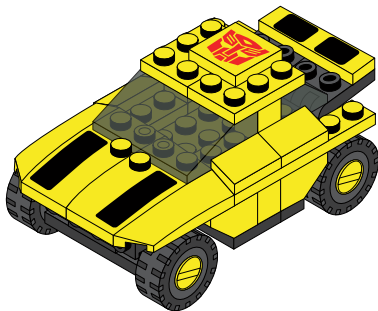
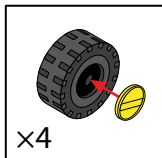

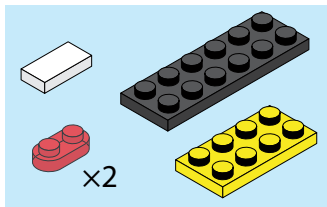

20

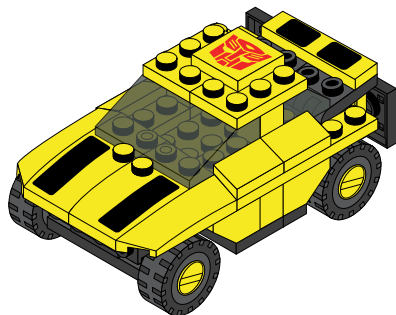
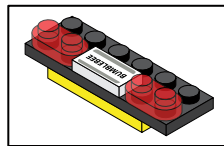
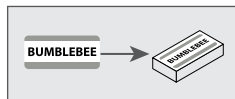

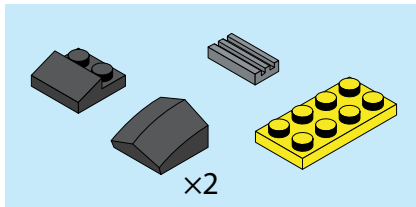

21

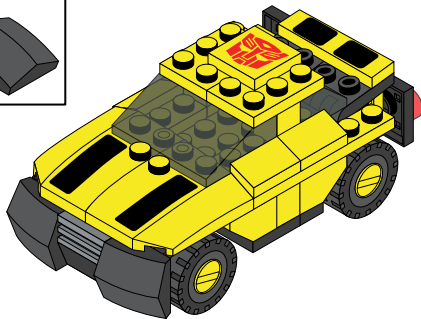
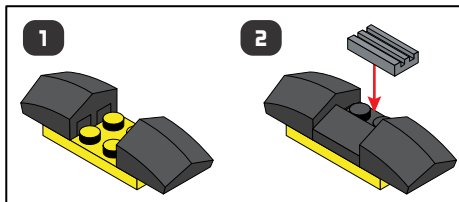



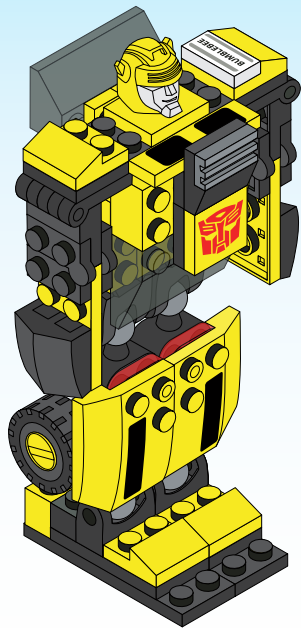

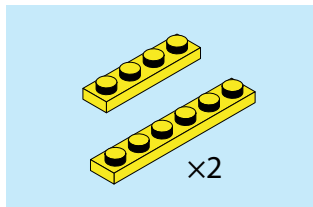
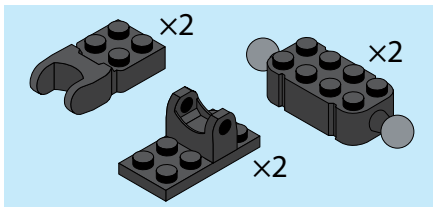

1

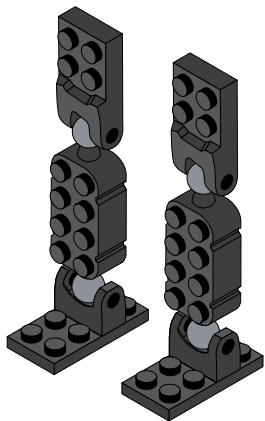
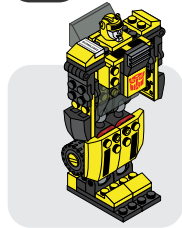

2

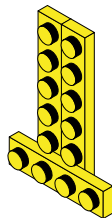

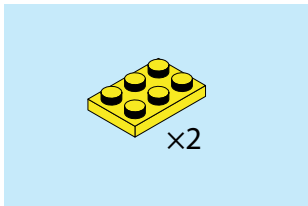

3

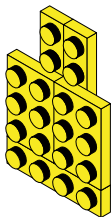

4

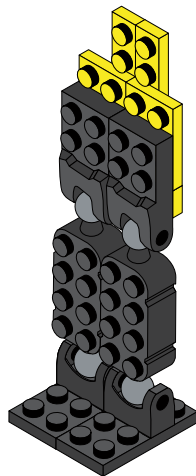

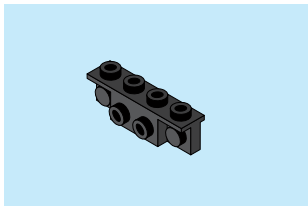

5

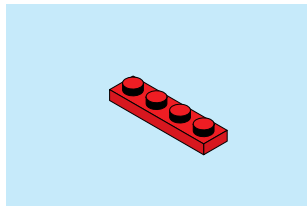
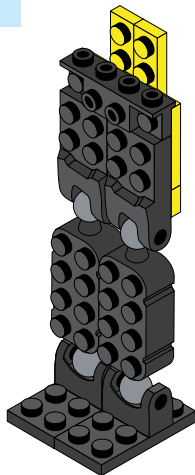

6

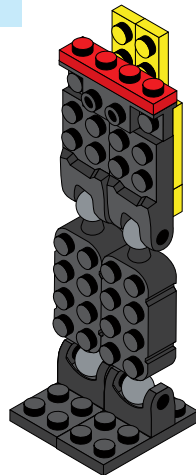

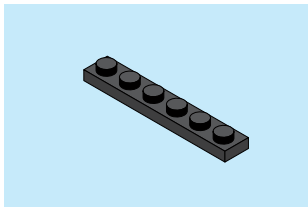

7

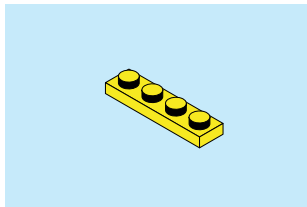
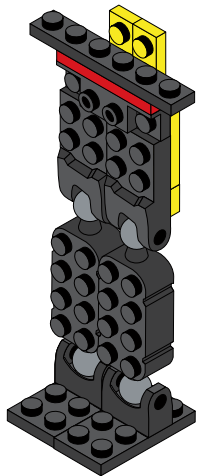

8

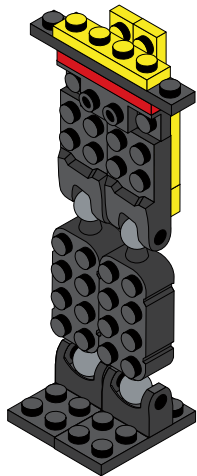

 x2

9

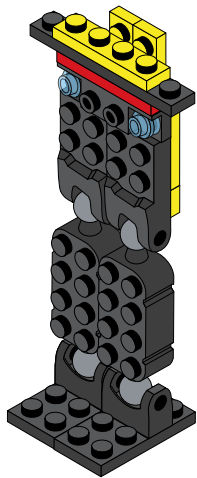

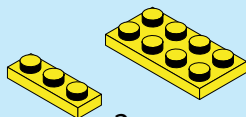
 x2

10

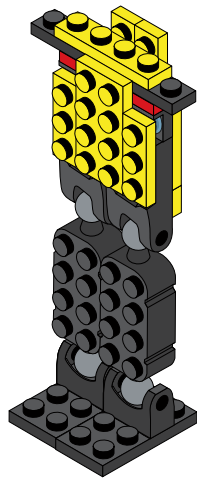

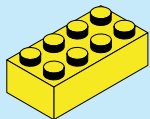

11

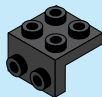
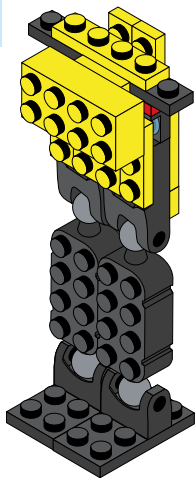

12

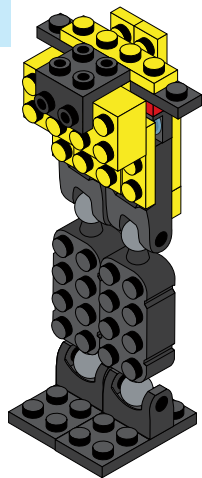

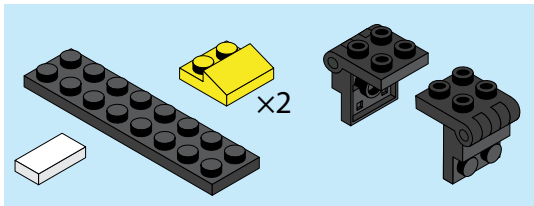

13

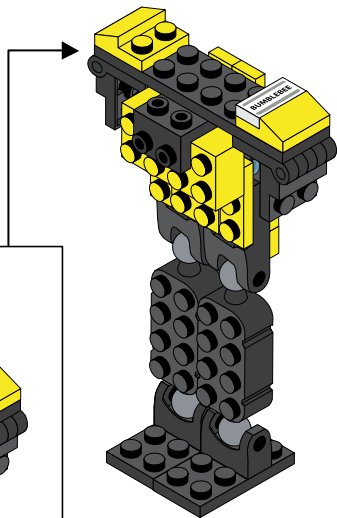
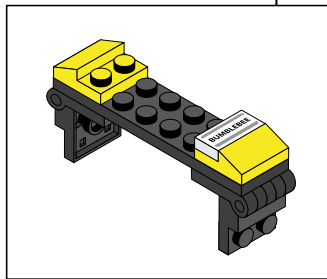
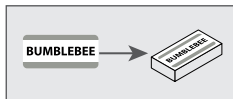



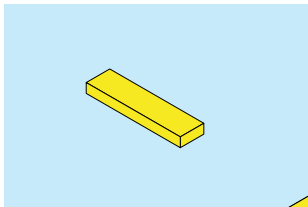

14

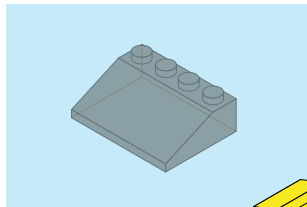
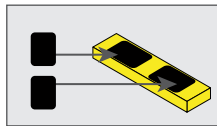
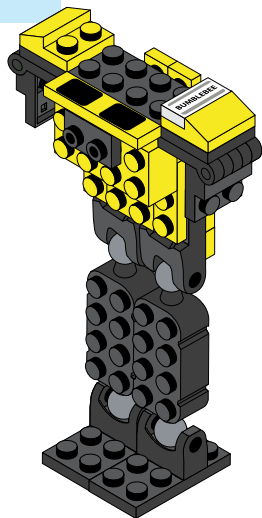

15

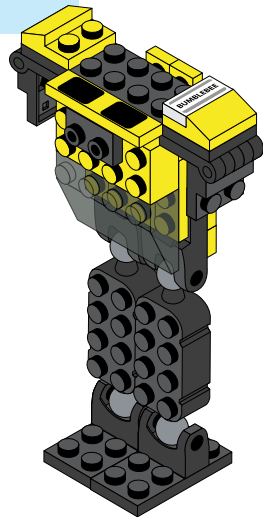

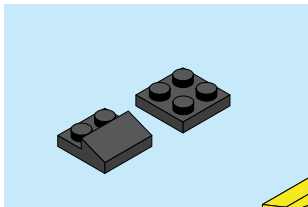

16

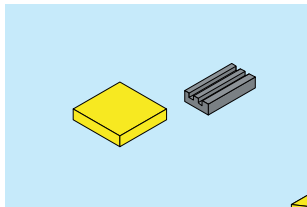
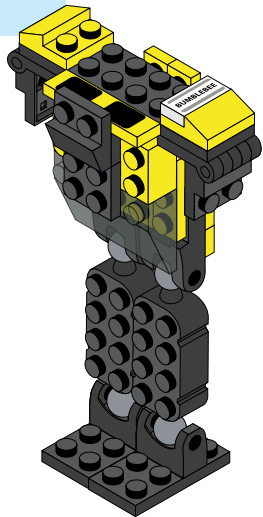

17

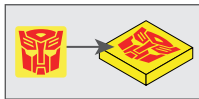
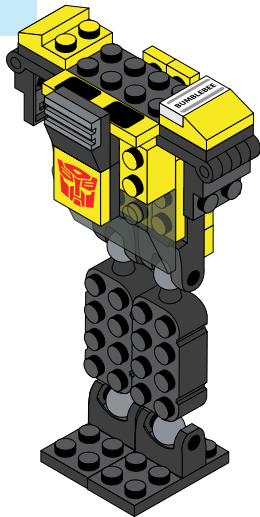

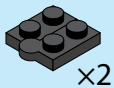

18

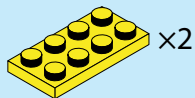
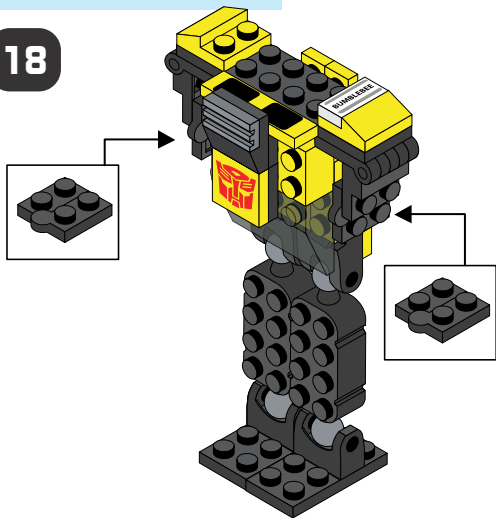

19

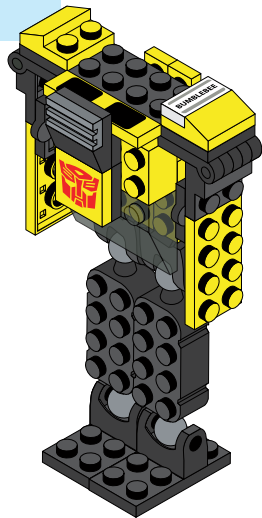

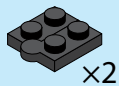

20

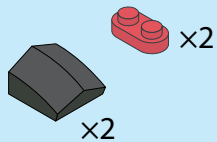
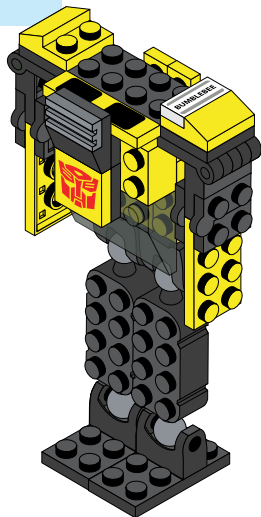

21

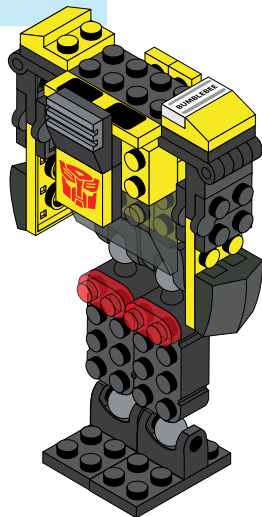

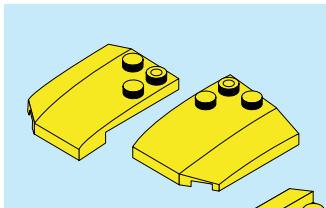

22

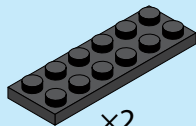
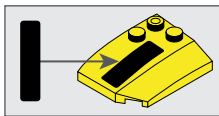
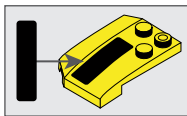
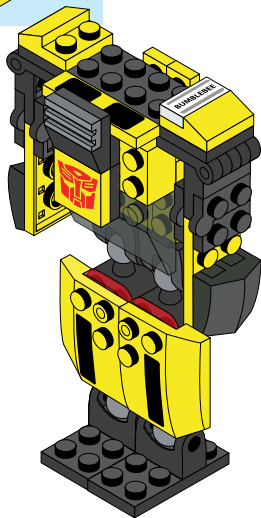

x2

23

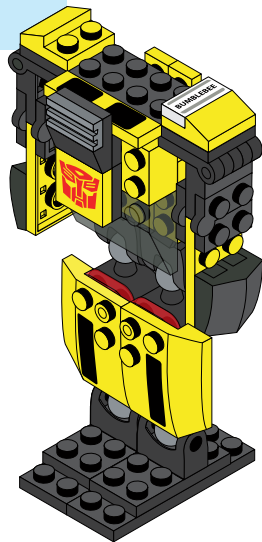



24

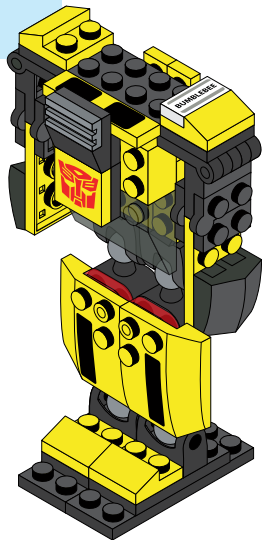

25

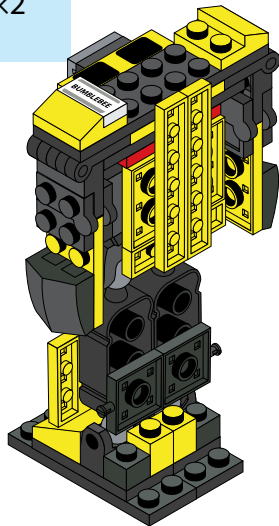
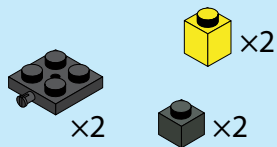

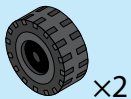

26

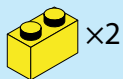
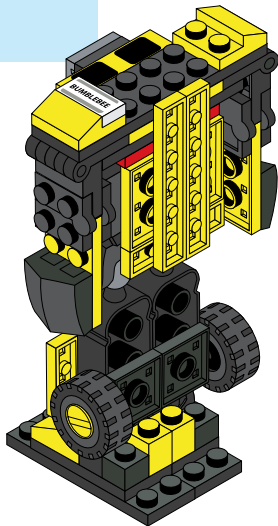
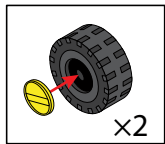

27

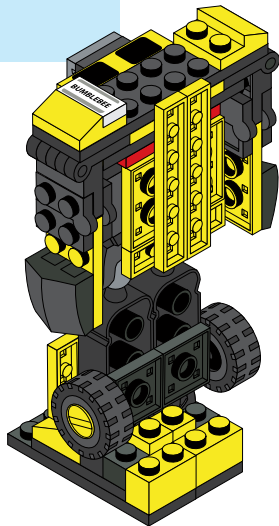

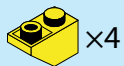

28

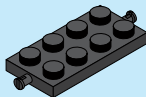
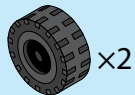
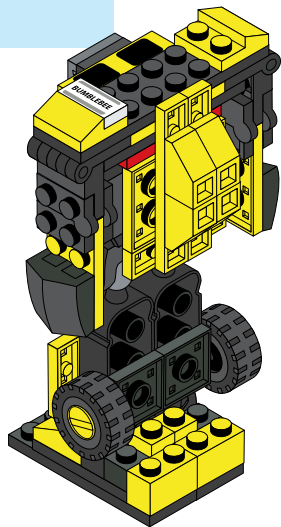

29

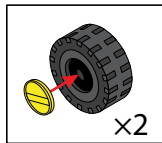
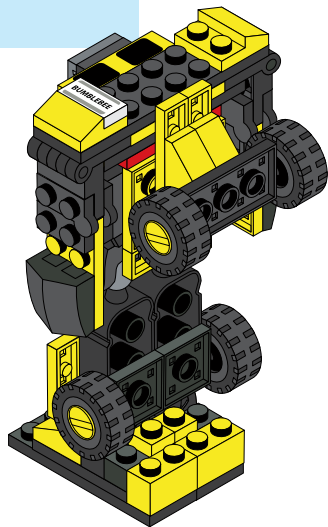



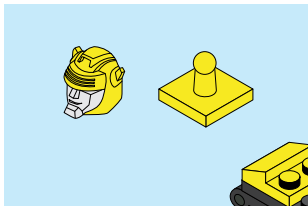

30

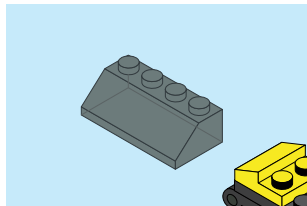
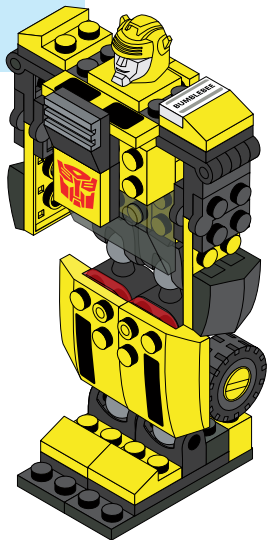
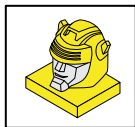

31

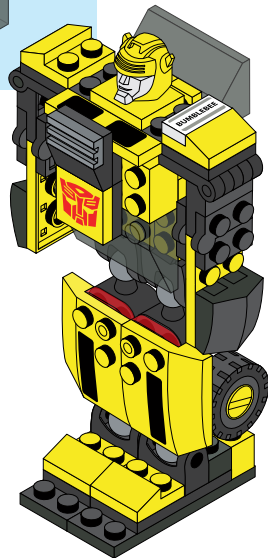

#00368



x2

#00018

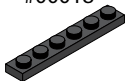

#00052



x2

#00221



#00020



#00213



x4

#00179



x2

#10010



#10009



#00126



#10016



x2

#00447

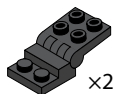

x2

#10001

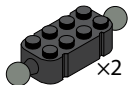

x2

#00023

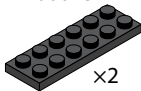

x2

#10066

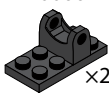

x2

#00024

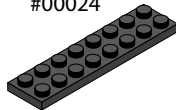

#10064



x2

#00017



#00032



#00054



x4

#00044

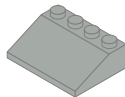

#00041

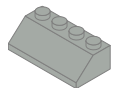

#00056



#00001



#10048



#00016



#00021



#00003



#10060



#00221



#00033



#00017



#00022

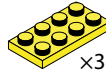

#00010

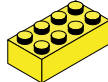

#10067



#00175



#00018

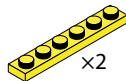

#10003

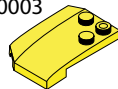

#10002

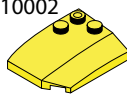

#10004



#00015



Questions? Call 1-800-752-9755

RETAIN INSTRUCTIONS FOR FUTURE REFERENCE. SOME POSES MAY REQUIRE ADDITIONAL SUPPORT. PRODUCT AND COLORS MAY VARY. © OXFORD. © 2011 HASBRO. ALL RIGHTS RESERVED. TM & ® DENOTE U.S. TRADEMARKS.



LOOK FOR THESE OTHER KRE-O™ CONSTRUCTION SETS

3 1 1 4 3  
OPTIMUS PRIME®



3 1 1 4 5  
MIRAGE®



EACH SOLD SEPARATELY

Questions? Call 1-800-752-9755



RETAIN INSTRUCTIONS FOR FUTURE REFERENCE.  
SOME POSES MAY REQUIRE ADDITIONAL SUPPORT. PRODUCT AND COLORS MAY VARY.  
© OXFORD. © 2011 HASBRO. ALL RIGHTS RESERVED. TM & ® DENOTE U.S. TRADEMARKS.



PIN 7170930001